

Class 300 • Rising Stem • Threaded Ends

Figure 384P

Size Range:
1/4" through 2"

Working Pressures Non-Shock:
300 psi Steam, Basic Rating
1000 psi Cold Working Pressure

Features

- Ideal for non-shock, severe service, such as throttling soot blower, blow-off, boiler feed, and drip and drain lines
- Plug Type Disc
- Union Bonnet
- Threaded Ends
- Wide Seating Surfaces
- 450 Brinell Hardened Stainless Steel Seat Ring
- Backseat
- MSS Specification SP-80

For more detailed features, refer to page 34.

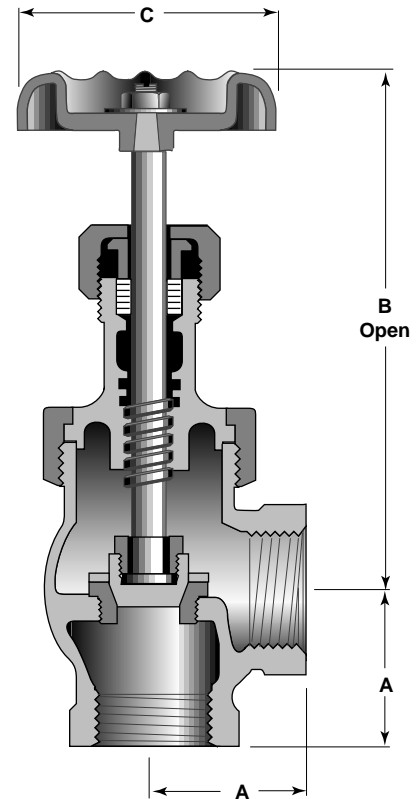

Principal Parts & Materials

Part	Sizes	Material	ASTM
Body	All	Bronze	B61 C92200
Bonnet	1/4" - 3/8"	Brass	B16 H02
Bonnet	1/2" - 2"	Bronze	B61 C92200
Disc	All	Stainless Steel	A276 S42000
Stem	All	Bronze	B371 C69400
Seat Ring	All	Stainless Steel	A276 S42000

Dimensions and Weights

Inches (millimeters) - pounds (kilograms)

	1/4 (6)	3/8 (10)	1/2 (15)	3/4 (20)	1 (25)	1 1/4 (32)	1 1/2 (40)	2 (50)
A	1.14 (29)	1.17 (30)	1.13 (29)	1.37 (35)	1.63 (41)	2.03 (52)	2.19 (56)	2.74 (70)
B	4.24 (108)	4.21 (107)	4.01 (102)	4.97 (126)	5.35 (136)	6.31 (160)	6.99 (178)	7.17 (182)
C	2.13 (54)	2.13 (54)	2.50 (64)	2.96 (75)	3.00 (76)	3.76 (96)	4.60 (117)	5.26 (134)
WTS.	1.00 (0.45)	0.90 (0.41)	1.30 (0.59)	2.20 (1.00)	3.30 (1.50)	5.70 (2.59)	7.70 (3.49)	13.10 (5.94)